

NAPOLY

120 cm



SZERELÉSI ÚTMUTATÓ

Gardrób csomag tartalma:

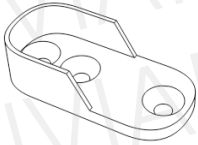

rúdtárcsa 2db



3,5x16 csavar 4db

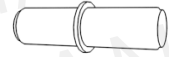

polctartó 4db

(A csomagok több alkatrész tartalmazhatnak, mint amennyire szüksége van!)

Szükséges szerszámok:

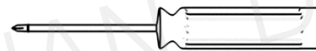

Ne egyedül végezze az összeállítást!

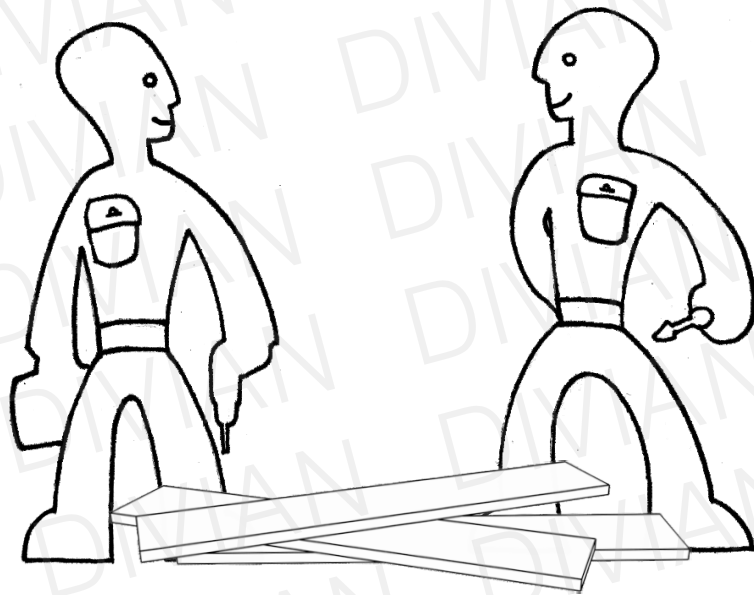

Óvja az elemeket a sérülésektől!

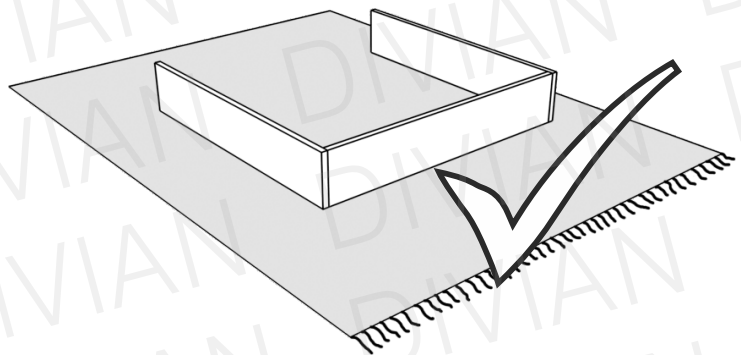
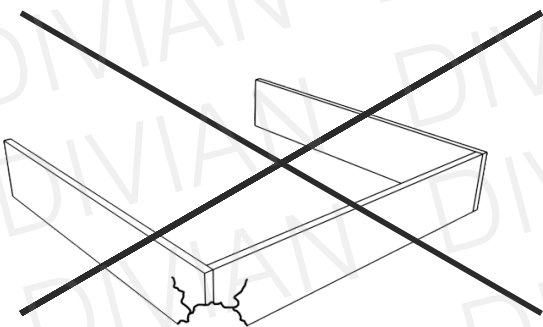

ELEMEK

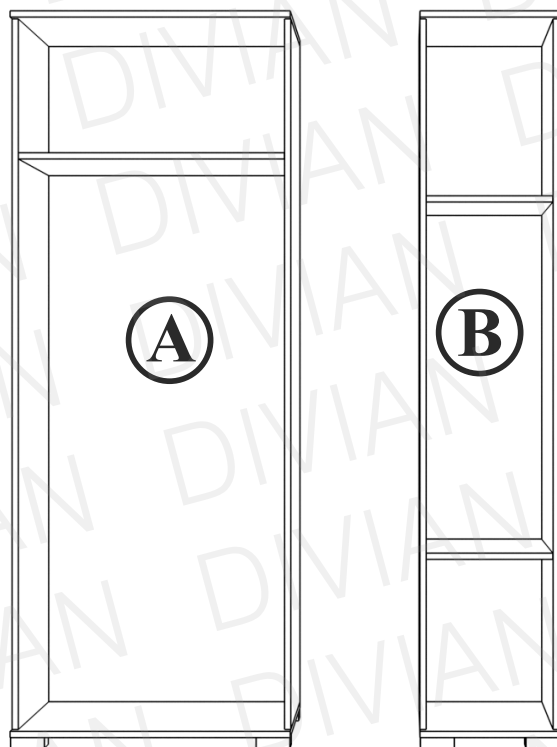

A könnyebb áttekinthetőség érdekében a szerelési útmutatóban az adott elemeket ajtók nélkül ábrázoljuk. Az összeszereléshez Önnek természetesen nem szükséges levennie az ajtókat!

1

2x



4x

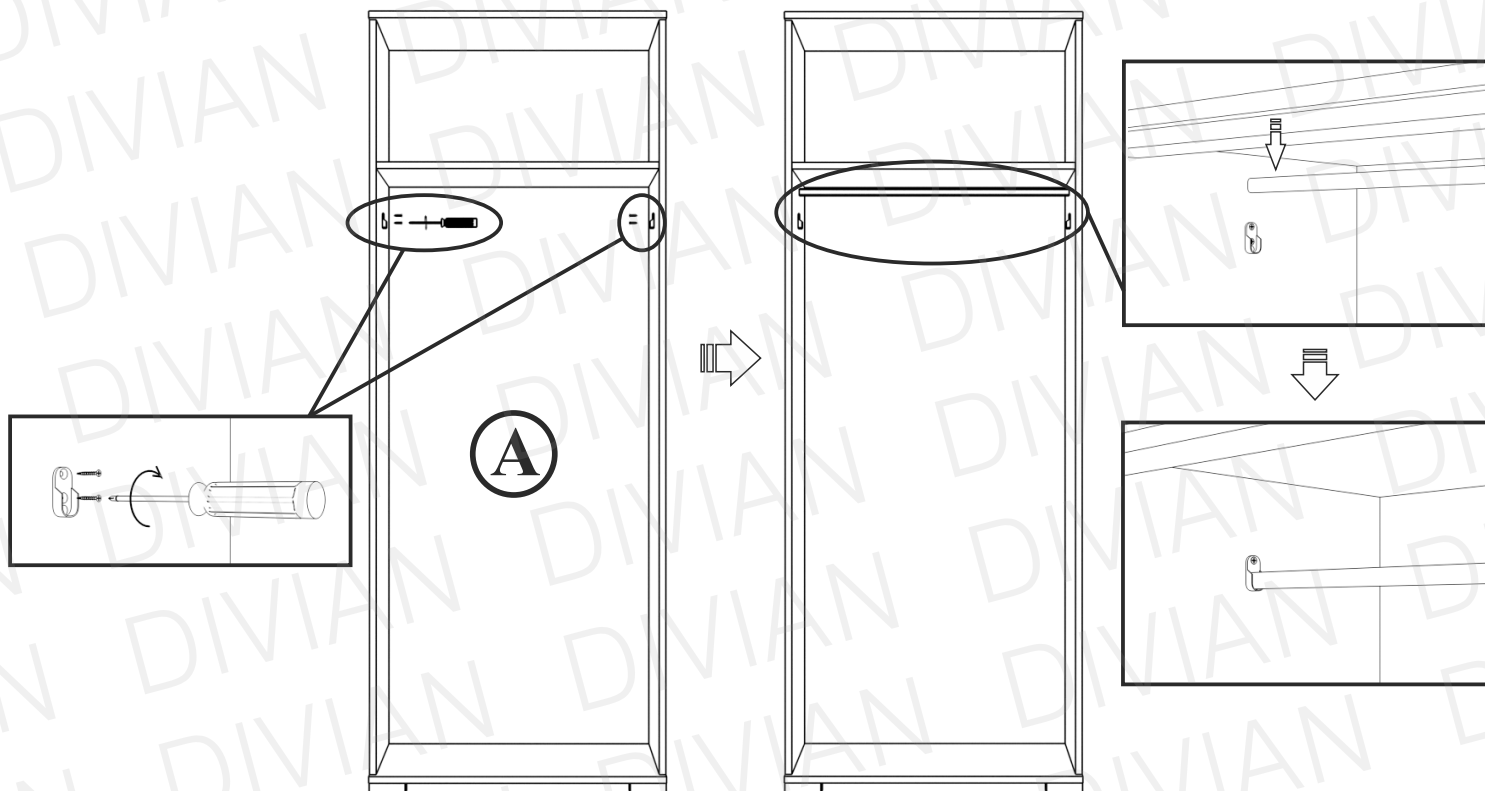

2

4x

